

Operating Manual for Model :

Model 4003 Temperature Indicator



Safety

This equipment is supplied by a mains voltage which can cause an electric shock injury. Before removing the circuit board from its housing, switch the instrument off, isolate it from the mains power supply and make sure that it cannot be connected inadvertently by other persons.

If the circuit board is removed from its housing, do not apply power to the instrument unless specifically instructed to do so in these instructions. When working on live equipment, exercise great care, use insulated tools and test equipment, and do not work alone.

When fitting option boards, always put the circuit boards back in the housing with the back-plate securely fastened before powering up the instrument.

When handling circuit boards, ensure that full anti-static precautions are observed.

Replace external mains fuse with one of an equivalent type.

Cleaning

Do not clean the instrument while the instrument is on. Harsh abrasives, solvents, scouring cleaners and alkaline cleaning solutions, such as washing soda, should not be used especially on the display window. The outside of the instrument may be wiped down with a slightly damp clean cloth (lightly moistened with water only). Under no circumstances should you attempt to wipe the inside of the instrument.

Contents

Introduction	Page 4
Electrical specifications	Page 4
Input ranges	Page 5
Programmable specifications	Page 5
Power supply	Page 5
Other specifications	Page 5
Installation (panel cutout)	Page 6
Installation (fastening)	Page 6
Display & keypad (during normal display mode)	Page 6
Display & keypad (during programming mode)	Page 6
Connections & links	Page 6
Power supply links	Page 7
Programming chart	Page 8
Display codes explained	Page 9
Programming example	Page 10
Asciius protocol	Page 11
Option 3001-P / M, 3002, 3003, 3004.....	Page 12
Option 3004P / M, 3006,3009, 3010.....	Page 13
Option 3012, 3013, 3017-P,3017-M.....	Page 14
Option 3018-P / M, 3025, 3028.....	Page 15
Diagram "P"	Page 16
Diagram "M"	Page 16
Declaration of conformity	Page 16
Guarantee	Page 16

See last four pages for details of options fitted / available

Introduction

The Model 4003, 4 digit (9999) LED Universal Temperature Indicator / Controller is used in applications where temperature needs to be displayed & controlled.

This DIN 48x96, high accuracy, high-quality panel meter is designed for accurate measurement & display (in °C, °F or K) of temperature from thermocouples of Type J, K, N, R, S, T, W5 & from RTDs such as PT100. Ni100 RTD is available as an option as well as other thermocouple types. The thermocouple & RTD signals are accurately linearised by the internal micro-controller.

Options include programmable analog output, 1, 2, 3, or 4 alarm setpoints, peak / valley hold, RS232/485 communications & more. The analog output is rangeable from the front pushbuttons.

The instrument meets European Community EMC directive 89/336/EEC and Low Voltage directive 72/23/EEC.

The instrument is designed for non-grounded thermocouple probes only.

Electrical Specifications

Thermocouple input accuracy	: 0.5°C, or 1 count (Note 1)
RTD input accuracy	: 0.3°C, or 1 count
Cold junction accuracy	: 0.5°C after 30 minutes
Internal resolution	: 20000 counts (bi-polar)
Temperature coefficient	: 20 ppm / °C typical
Conversion & settling time	: 1 second
Operating temperature range	: -10 to +50°C
Storage temperature range	: -40 to +80°C
Humidity	: < 85% non-condensing
Warm-up time	: None required
Electro-mechanical relays	: 250V AC, 30V DC, 2A, PF=1
Solid state relays	: 400V AC/DC, 0.5A, PF=1
Analog output accuracy	: 0.1% of full scale, 12 bits
Current analog output load	: 500 Ω maximum
Voltage analog output load	: 1 kΩ minimum
Memory retention	: Full non-volatile operation
Option 3006 isolation rating	: 1500 V
Declaration of conformity	: See last page

Note 1: Overall accuracy is dependent on the thermocouple type. The table below lists the designated minimum standard error of some thermocouple types:

Type:	J	K	R	S	T
Minimum Std Error:	±2.2C	±2.2C	±1.4C	±1.4C	±0.8C

Input Ranges

The temperature probes are accurately linearised in the following temperature ranges:

Type J	: -25°C to +900°C
Type K	: -25°C to +1275°C
Type N	: +200°C to +1200°C
Type S	: +625°C to +1750°C
Type R	: +625°C to +1750°C
Type T-	: -235°C to +25°C
Type T+	: -35.0°C to 330.0°C
Type W5	: +1150°C to +2050°C
PT100	: -165.0°C to +600.0°C (max 999.9°F)
Ni100 (optional)	: -60.0°C to +235.0°C
PT500 (optional)	: -165.0°C to +600.0°C (max 999.9°F)
PT1000 (optional)	: -165.0°C to +600.0°C (max 999.9°F)
TC resolution	: 1°C (Type T+ is 0.1°C)
RTD resolution	: 0.1°C

Power Supply

Standard

115 / 230 VAC ± 10%, link selectable, 50/60Hz, 5VA typ

Optional

10 - 30VDC isolated power supply (Option 3008), 5VA typ
 95V-265V AC/DC isolated power supply (Option 3010), 5VA typ
 8 - 30VDC non-isolated (Option 3028), 5VA typ

Programmable Specifications

Thermocouple type	: J, K, N, S, R, T-, T+, W5
RTD type	: PT100
Optional RTD types	: Ni100, PT500, PT1000
Display	: °C, °F or Kelvin (absolute temperature)
Broken TC protection	: Selectable high or low
Broken RTD protection	: Selectable high or low

Options :

Analog output zero & span	: -1999 to 9999
Alarm setpoint values	: -1999 to 9999
Alarm hysteresis	: 0 to 255 (default 1)
Alarm delay	: 0 to 255 seconds (default 0)
Alarm relay settings	: Selectable HIGH or LOW alarm
Alarm relay state	: Selectable NO or NC
Unit address	: 1 to 127
Baud rate	: 2400, 4800, 9600, 19200

Other Specifications

DIN 48 x 96 housing, 147mm depth
 Industrial strength single piece housing

Housing is flame retardant ABS plastic that meets UL94 V-0
 Circuit board is flame retardant material that meets UL94 V-0

Front fascia rating : IP65 (with o-ring seal supplied as standard)

Installation

Panel Cutout

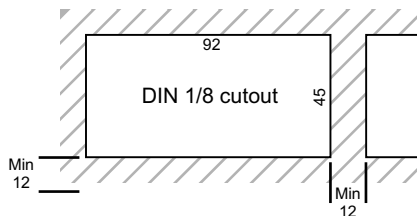

Installation

Fastening

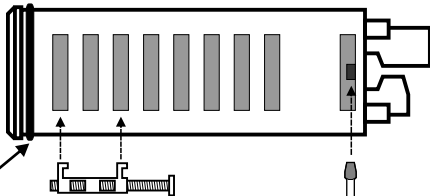

O-ring sealing gasket supplied as standard

The supplied fastening clips may be fitted on **the side** or the **top / bottom** of the housing. Ensure that the clip & screw is mounted as shown here.

Caution : Do not overtighten the screws.

To gain access to the circuit boards, switch power off and remove terminals from the back of the housing. Observe safety precautions. Use a screwdriver to clip the back-plate off.

During normal display mode

Display & Keypad

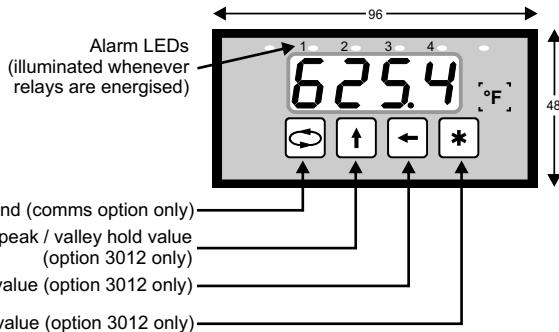

During programming mode

Display & Keypad

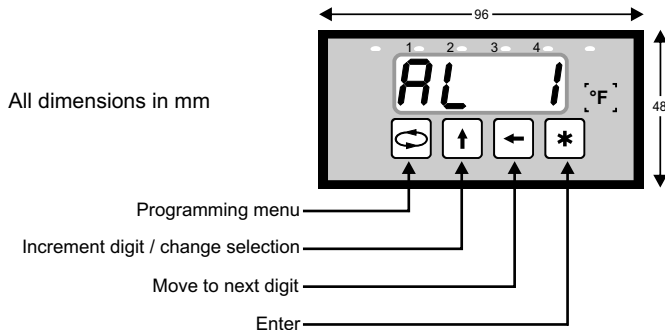

Connections & Links

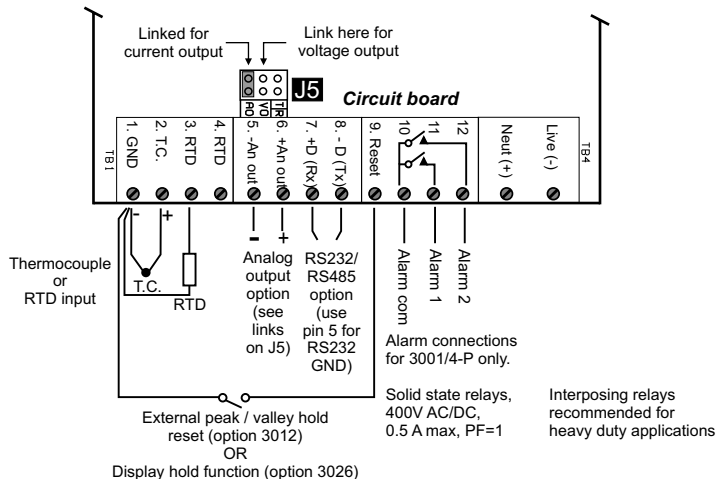

Power Supply Links

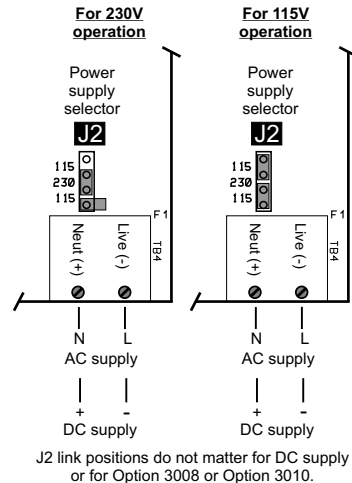

Programming Chart

READ ME FIRST !

- Note 1 : This programming chart is a simplified flowchart for users that have previous experience with this instrument. A programming example is available in the next few pages to assist new users in understanding this programming chart.
- Note 2 : Because this instrument has many options, all possible option menus are shown. Options that are not ordered will not appear in the programming sequence.
- Note 3 : Configuring this instrument requires two steps. (A) Select analog output (option) links (page 6). (B) Program the instrument with this chart.
- Note 4 : To enter programming mode, press the menu key for a few seconds (unless the optional keypad lock has been set). Programming mode timeout is about 20 seconds. If no key is pressed for 20 seconds during programming, the instrument returns to normal display mode.
- Note 5 : The selection of the display engineering units (°C, °F, or K) does not automatically change the alarm setpoint units, analog output range etc. If

START HERE

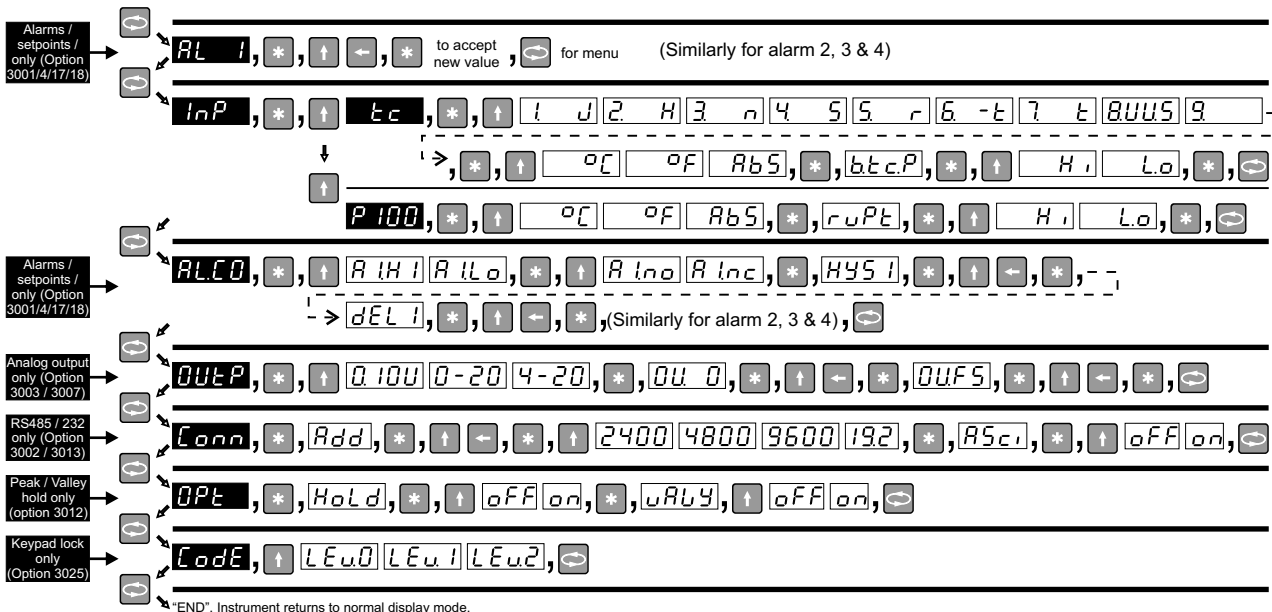

Display Codes Explained

AL 1 **AL 2** **AL 3** **AL 4** 1st, 2nd, 3rd, 4th setpoint value

ALCO Alarm configuration menu (shown for 1st alarm only)

ALH1 **ALO** 1st alarm setpoint select HIGH / LOW alarm

ALno **ALnc** 1st alarm setpoint normally OPEN / CLOSED contact

HYS1 1st alarm setpoint hysteresis

dEL1 1st alarm setpoint delay

OUTP Analog output menu

0.10V **0-20** **4-20** Output selection (0-10V, 0-20mA, 4-20mA)

OUO Output zero selection

OUFS Output full scale selection

Conn Communications menu (RS232 / RS485)

Addr Unit address (default 0)

2400 **4800** **9600** **192** Available baud rate values

ASC **OFF** **on** Protocol selection. On = AsciiBus. Off = DigiBus.

OPT Option menu for Auto-zero feature and Peak / Valley Hold feature

Hold **OFF** **on** Peak / valley hold option turned off or on

VALY **OFF** **on** Peak OR valley hold. "off" = peak. "on" = valley

Code Keypad lock security menu. See Option 3025 for more information

LEu0 **LEu1** **LEu2** Keypad lock security level. Level 0 = none, Level 1 = alarm value changes, Level 2 = full

oooo **8888** Process overscale. Input has exceeded full scale value. / Display test mode.

---- Hardware overrange. Reduce input signal to reduce saturation.

INP Input selection menu

tc Thermocouple input selection menu

P100 PT100 RTD input selection menu (this menu is also used for PT500 and PT1000 input options)

n100 Nickel 100 RTD input selection menu (this menu will appear in place of the "P100" menu if ordered)

1J Type J thermocouple input

2K Type K thermocouple input

3N Type N thermocouple input

4S Type S thermocouple input

5R Type R thermocouple input

6-t Type T negative thermocouple input

7-t Type T positive thermocouple input

WU5 Type W5 thermocouple input

9 Reserved for future use

oC Degrees celcius selection for display

oF Degrees fahrenheit selection for display

ABS Absolute / Kelvin temperature selection for display

btcP **H** **L** Broken thermocouple protection, read high or low

rupT **H** **L** Open / short circuit RTD protection, read high or low

Please Note :

PASS

If the front keypad has been locked, then the word "PASS" will appear. See option 3025 for more information.













Please Note :

Display screens shown in black are to indicate the beginning of sub-menus.



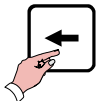

Programming Example

Setting Up Alarm Values (Option)

Remember, the symbols on the keypad have the following definitions during programming.

 Next Menu Item	 Increment digit	 Next Digit	 Enter / Accept value
	Press "Menu" for 3 seconds		
	Press "Enter" to see Alarm / Trip 1 value.		
	Press "Increment digit" to increase value		
	Press "Next digit" to amend the next digit		

Amend the other digits in the same way until the desired trip value is entered.

	Press "Enter" to accept Alarm 1 value.	
	Press "Menu" to proceed to next trip value.	

Use the same menu steps above to change trip levels for trip 2, 3 and 4.

The entire programming menu operates in a manner similar to the example described above.

IGNORE THIS PAGE unless communications option has been ordered. When the RS232 (option 3013) or RS485 (option 3002) is ordered, two protocols are made available, namely ASCIIbus & DIGIbus protocols. DIGIbus is the default protocol which is used for the calibration and configuration of the instruments, and whenever the instrument is connected to master-slave systems. DIGIbus protocol is therefore used in complex bus systems, and is NOT described here. Please contact factory for the DIGIbus protocol.

ASCIIbus, which is described here, is much easier to use as it can easily interface to third party systems with very little engineering work required. It is a purely ASCII based (7 bit) protocol. The protocol is essentially designed for one way communications (instrument to PC). Under the "Conn" (connection) programming menu, ASCIIbus is enabled by selecting "ASCII" to "ON". If "OFF" is selected, the DIGIbus protocol will be active. Although designed for one way communications only, the ASCIIbus protocol contains an address. The address range is "00" to "99".

Using address "00" : If this address is selected, the instrument will only transmit data on demand by either momentarily pressing the 'menu' key, or by transmitting a byte (any ASCII character) to the DPM. This mode is useful for interfacing to printers. In addition, field 'AA' will contain the ASCII character "blank/space". Field 'P' will also contain the ASCII character "blank/space".

Using address "01" to "99". If any of these addresses are used, the meter continuously transmits information at approximately 5 times a second.

The data format string output from the indicator is (7 bit ASCII code is used):

Line Settings : 7 Data Bits, 1 Parity bit, Odd Parity, 1 Stop Bit.
 Baud Rate : Selectable 2400, 4800, 9600, 19200.
 Data Bits : Numerical ASCII characters : 0, 1, 2, 3, 4, 5, 6, 7, 8, 9
 Other ASCII characters : #, blank/space, +, -, CR, LF
 Protocol format is : # A A S D D D D D D D P CR LF
 where : # = indicates start of message
 : AA = Instrument address. ASCII 00 to 99. 00 is default.
 : S = sign (polarity) (ASCII "+" or "-").
 : D = data bits (data for 8 numerals). See Note (1).
 : P = decimal point position. ASCII 0 to 8.
 : CR = ASCII carriage return.
 : LF = ASCII line feed.

The output will follow the display reading. This means that if the peak-hold option has been ordered and activated, the communications output will peak-hold as well.

Note 1 : This protocol allows for future expansion. Therefore if Model 4001 is used for example, the first four digit data will contain the ASCII character "blank/space" and the last four digits will contain the display reading. Similarly, if the Model 5001 is used for example, the first 2 digit data will contain the ASCII character "blank/space" and the last six digits will contain the display reading.

Option 3001-P**Two Setpoint Alarms (Solid State Relays)**

See page 7 for connection details. Wire for AL1 & AL2 only.

Option 3001-M**Two Setpoint Alarms (Electro-Mechanical Relays)**

This option provides two alarm setpoints with electro-mechanical relays. This option board slots into the upper slot of the panel meter box. The upper terminals are clearly numbered 13-28 to differentiate them from the lower terminals. Both normally open and normally closed contacts are provided with each relay. The relays are rated at 250VAC / 30VDC @ 2A. Visual LED alarm indication is provided on the panel meter front. For connection wiring details, see diagram "M" on page 16. Connect wires for AL1 & AL2 only.

Option 3002**RS485 Serial Interface Option**

See page 7 for connection details. Select DIGIbus or ASCIIbus protocol from the program menu. See additional protocol documents.

Option 3003**0 - 20mA / 4 - 20mA / 0 -10V Analogue Output Option**

See page 7 for connection details.

Option 3004-P**One Setpoint Alarm (Solid State Relay)**

This option is similar to Option 3001-P but with a single alarm only. See page 7 for connection details. Wire for AL1 only.

Option 3004-M**One Setpoint Alarm (Electro-Mechanical Relay)**

This option is similar to Option 3001-M but with one alarm setpoint only. See diagram "M" on page 16 for connections. Wire AL1 only.

Option 3006**Isolated Options (Analogue Output / RS232 / RS485)**

This is ordered with option 3002, 3003, 3007 or 3013. It provides a minimum of 1500V isolation between input and output signal. Wiring connections are different for these isolated options. Use diagram "P" or diagram "M" on page 16 for wiring connections.

Option 3008**Galvanic Isolation (8 - 30VDC Supply) Option**

This power supply option provides 8 - 30VDC supply isolation. See page 7 for connection details.

Option 3009**Parallel BCD Output Option**

This option is supplied as an additional slot in card in the top part of the instrument housing. See additional documentation.

Option 3010**95V-265V AC / DC Power Supply Option**

This options allows the instrument to operate from a wide range of AC & DC power supplies. The supply connections are on page 7.

Option 3012**Peak Or Valley (Max or Min) Hold Option**

This option displays and holds the max or min value (not both) of an input signal. This option is activated in the programming menu "Opt" by selecting whether "Hold" should be "On" or "Off", and selecting valley ("valy" = "On") or peak ("valy" = "Off") mode.

To show peak / valley value, press the "up" arrow for 3 seconds. To show normal display value, press the "side" arrow key for 3 seconds. To reset the peak / valley hold value, press the "star" key for 3 seconds, or use an external potential free contact (see page 7 for connection details). If analog output option is fitted, the output will hold as well.

Option 3013**RS232 Serial Interface Option**

See the additional pages supplied for protocol details & page 7 for connection details. Ensure that maximum cable length from instrument to PC is less than 15 metres.

Option 3017-P**Three Alarm Setpoints (Solid State Relays)**

This option provides three alarm setpoints with solid state relays. This option board slots into the upper slot of the panel meter box. The upper terminals are clearly numbered 13-28 to differentiate them from the lower terminals. Only normally open contacts are provided, which means that should the contacts be closed and the power fails, they will revert to a normally open condition. The relays are rated at 400V AC /DC @ 0.5A. Visual LED alarm indication is provided on the panel meter front. For connection wiring details, see diagram "P" on page 16. Connect wires for AL1, AL2 & AL3 only.

Option 3017-M**Three Alarm Setpoints (Electro-Mechanical Relays)**

This option provides three alarm setpoints with electro-mechanical relays. This option board slots into the upper slot of the panel meter box. The upper terminals are clearly numbered 13-28 to differentiate them from the lower terminals. Both normally open and normally closed contacts are provided with each relay. The relays are rated at 250VAC / 30VDC @ 2A. Visual LED alarm indication is provided on the panel meter front. For connection wiring details, see diagram "M" on page 16. Connect wires for AL1, AL2 & AL3 only.

Option 3018-P**Four Alarm Setpoints (Solid State Relays)**

This option is similar to option 3017-P, but contains four relays (see option 3017-P). For connection wiring details, see diagram "P" on page 16. Connect wires for AL1, AL2, AL3 & AL4.

Option 3018-M**Four Alarm Setpoints (Electro-Mechanical Relays)**

This option is similar to option 3017-M, but contains four relays (see option 3017-M). For connection wiring details, see diagram "M" on page 16. Connect wires for AL1, AL2, AL3 & AL4.

Option 3025**Keypad Lock Option**

The keypad lock option is used to prevent un-authorized access to the programming menu. When this option is ordered, a new sub-menu called "CODE" appears at the end of the programming sequence. See programming page 8.

Three levels of keypad lockout are available: Level 0 - Full access to programming menu. Level 1 - User only has access to alarm setpoint values. Level 2 - Total programming menu lockout.

If this option is ordered, the factory default is "Lev 0". If the keypad has been locked with either level 1 or 2, then the word "PASS" will appear on the display if the user attempts to enter programming mode. Pressing the menu key will return the instrument to normal display mode. However, if the user wishes to enter the programming menu, then when the word "PASS" appears, press in succession, 1 second apart, all four keys from right to left.

Option 3028**Non isolated(8 - 30V Supply) Option**

This option provides an 8 to 30VDC non-isolated power supply. See page 7 for connection details.



Declaration of Conformity

Diagram "P"



Upper Terminals
(Option boards)

Lower Terminals
(Mother board)

Universal Temperature Indicator / Controller

Manufacturer : DPM

Type : 4003

Options : 3000 to 3028

Corresponds to the requirements of the following EC directives:

EMC directive	: 89/336/EEC
Low voltage directive	: 73/23/EEC
The applicable harmonised standards are	: EN 50081-1
	: EN 50082-1
	: EN 61010

Diagram "M"

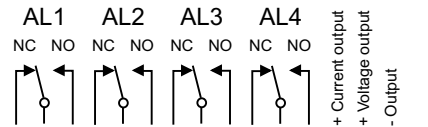

Upper Terminals
(Option boards)

Lower Terminals
(Mother board)

Guarantee

This product is guaranteed against faulty workmanship or defective material, for a period of 3 (three) years from date of delivery.

The manufacturer undertakes to replace without charge all defective equipment which is returned to it (transportation costs prepaid) during the period of guarantee, provided there is no evidence that the equipment has been abused or mishandled in any way.

The manufacturer reserves the right to alter any specification without notice.